

Pablo®

ELISE

INFO@PABLODESIGNS.COM
888 MARIN STREET
SAN FRANCISCO, CA
94124

PABLODESIGNS.COM

Pablo®

ELISE

32, 48, 60, 80 ASSEMBLY & INSTALLATION INSTRUCTIONS



APPROVED COMPONENTS

Pablo® ELISE

ELISE MODELS



ELISE 80



ELISE 60



ELISE 48



ELISE 32

BULB TYPE
ELISE 32,48,60: 11PAR30SNDIM/927SP15
ELISE 80: 5.5PAR38DIM/927SP15



CARE INSTRUCTIONS
WIPE CLEAN WITH A SOFT DAMP CLOTH.
AVOID AMMONIA-BASED CLEANERS.

ASSEMBLY

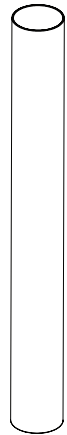

1 REMOVE SHADE AND BULB FROM BASE

NOTE: ELISE 80 BASE AND SHADE
SHIP SEPARATELY.

Pablo® ELISE

ASSEMBLY

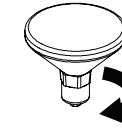

2 UNWRAP BULB AND SCREW INTO SOCKET

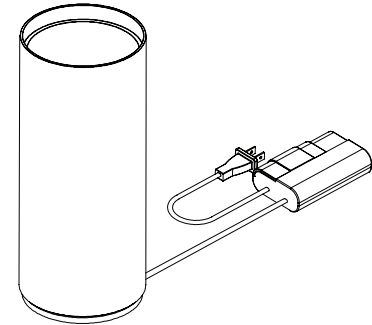

ASSEMBLY



3 INSERT SHADE INTO BASE WITH
LOGO SIDE DOWN.

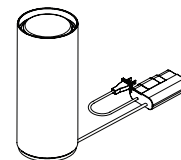

Pablo®

ELISE

INFO@PABLODESIGNS.COM
888 MARIN STREET
SAN FRANCISCO, CA
94124

PABLODESIGNS.COM

Pablo®

ELISE

12 & 18 ASSEMBLY & INSTALLATION INSTRUCTIONS



APPROVED COMPONENTS

Pablo® ELISE

ELISE MODELS



ELISE 12

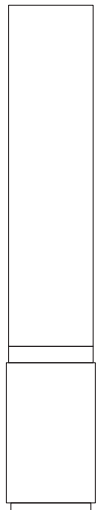

ELISE 18

BULB TYPE

ELISE 12 : E14 / 25W - TORPEDO FROSTED WHITE
ELISE 18 : E26 / 40W - T-10 FROSTED WHITE

CARE INSTRUCTIONS

WIPE CLEAN WITH A SOFT DAMP CLOTH.
AVOID AMMONIA-BASED CLEANERS.

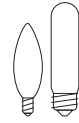

ASSEMBLY

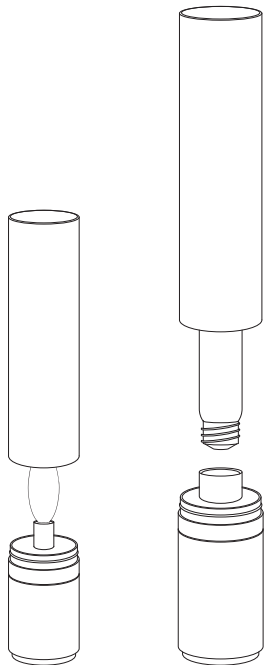

1 REMOVE SHADE AND BULB FROM BASE

ASSEMBLY

2 UNWRAP BULB AND SCREW INTO SOCKET

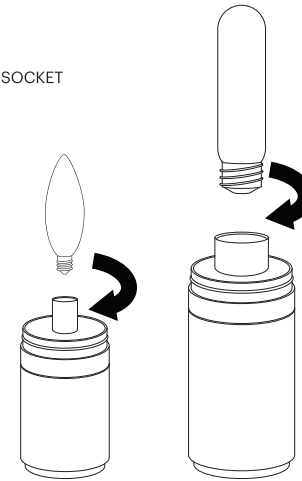

ASSEMBLY

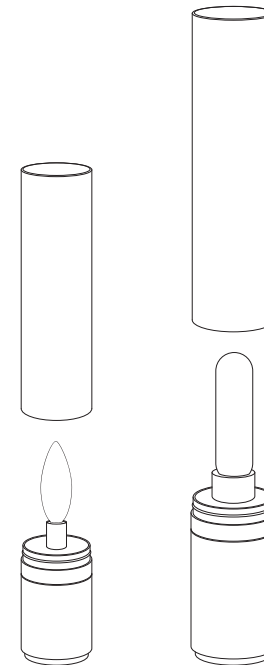

3 INSERT SHADE INTO BASE WITH
LOGO SIDE DOWN.